

INSTRUCTION MANUAL

PNEUMATIC SANDER

Please read this manual carefully before you attempt to use your tool so that you may use it properly and safely.

COMPACT MULTI SANDER

Model **CMX-20**

PROFESSIONAL TOOL

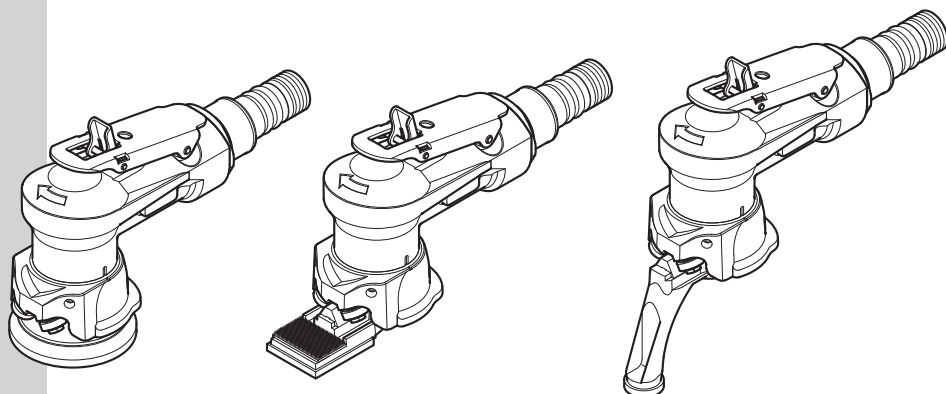

Specifications

Model		CMX-20		
		2" Pad	Rectangular Pad	Finger Pad
Maximum Operating Pressure	MPa	0.6		
Air Consumption (No Load)	m ³ /min	0.15		
Rated Speed (No Load)	min ⁻¹	14500	13000	13000
Orbit Diameter	mm	O.D.2 mm		
Pad Size	mm	φ50	26×50	φ16
Mass (Weight)	kg	0.53(Without Pad)		
Sound Pressure Level	dB(A)	76		
Sound Power Level	dB(A)	87		
Vibration Level	m/s ²	≤ 2.5		

Due to continuous product development/improvement the specifications and configurations in this document are subject to change without prior notice.



Manufactured by :

NITTO KOHKI Co., Ltd.

9-4, NAKAIKEGAMI
2-CHOME, OHTA-KU,
TOKYO, 146-8555, JAPAN

Tel : +81-3-3755-1111

Fax : +81-3-3753-8791

Keep the manual handy – so you can use it whenever necessary.

Original Instructions

Thank you very much for your purchase of this **Nitto Kohki product**.







Before using your tool, please read this manual carefully so that you may use it properly to get the most out of it.

Please keep the manual handy - so you can use it whenever necessary.



- **English** : Please ask your dealer or distributor for instruction manual in local language(s).
- **German** : Bitte fragen Sie Ihren Händler nach eine Betriebsanleitung in Landessprache.
- **French** : S'il vous plait, veuillez demandez à votre fournisseur de manuel instruction en langue locale.
- **Spanish** : Por favor, contacte con su distribuidor para el manual de instrucciones en español.
- **Portuguese** : Por favor pessa ao seu agente ou distribuidor o manual de instruções em seu idioma local.
- **Italian** : Per Manuale Istruzioni in lingua locale Vi preghiamo di rivolgerci al rivenditore o distributore.
- **Dutch** : Vraag uw handelaar om een nederladstalige gebruiksaanwijzing.
- **Swedish** : Be er lokala Åtreförsäljare eller distributör om manualer på svenska.
- **Danish** : Venligst henvend Dem til den danske distributør for instructions manualer.
- **Polish** : Proszę pytać swojego dealera lub dystrybutora o instrukcje obsługi w języku lokalnym.
- **中文** : 請向當地供應商或經銷商詢問中文使用說明書

CONTENTS	page
IMPORTANT SAFETY INSTRUCTIONS	2
GENERAL: TOOLS	2
GENERAL: PNEUMATIC TOOLS	3
INSTRUCTIONS FOR THIS TOOL	4
1. USAGE	4
2. CHECK THE CONTENTS OF THE PACKAGE	4
3. NAME OF PARTS	5
4. AIR SUPPLY	5
5. HOW TO OPERATE THE TOOL	6
6. STORAGE	8
7. ORDERING SERVICE PARTS	8
8. OPTIONAL PARTS	8
9. EXPLODED DIAGRAM : CMX-20	9

PICTOGRAM

-  Warning: It might be dangerous to operate the tool if the instructions supplied are not followed.
-  Using this tool improperly could result in serious injury. Read the instruction manual before using.
-  Always wear suitable eye protection.
-  Always wear suitable hearing protection.
-  Always wear respiratory protective equipment (PPE).
-  Always wear protective gloves for protection of hands from Vibration and Shock

The following Safety notations are used throughout the manual to highlight safety precautions for the user and for the tool.

 WARNING:	Indicates a potentially hazardous situation which, if not avoided by following the instructions given, could result in death or serious injury.
 CAUTION:	Indicates a potentially hazardous situation which, if not avoided by following the instructions given, could result in injury or material damage.

Please note, however, that failure to observe safety precautions under the “**Caution**” category could result in a serious occurrence depending on the situation: please observe all safety precautions in the manual.

Caution: Important precautions for tool setup, operation and maintenance.

IMPORTANT SAFETY INSTRUCTIONS

When using the tool, please observe the safety precautions below to prevent possible accident or injury.

GENERAL: TOOLS

WARNING

TO OPERATORS

- **Wear proper clothing for the type of work being done.**
Take care so that clothing, ties, hair, etc. will not become entangled with the moving parts. If items become entangled it will cause the operator to be pulled towards the tool and lead to possible cause of accident or injury.
- **Always wear suitable eye protection.**
Vision correction glasses are not safety glasses. Always wear appropriate safety glasses when doing your job.
- **Always wear suitable hearing protection.**
- **Wear respiratory protective equipment (PPE).**
Wear respiratory protective equipment (PPE) when working in an environment where dust particles are generated in operation.
- **Avoid working posture that is too stressful.**
Always ensure a firm footing and well balanced posture.
- **Do not operate the tool if you are too tired.**
- **Never touch any moving parts of the tool when running.**

ABOUT WORK AREA

- **Keep the work area clean.**
Cluttered work areas (e.g. workbench) invite accidents.
- **Carefully select the work area.**
Do not expose tool to rain.
Do not use tool in a wet or soaked area.
See that the work area is adequately illuminated.
- **Never work near inflammable liquid or in a potentially explosive atmosphere.**
- **Keep children away from the work area.**
Keep children and unauthorized people away from the work area to avoid accident or injury.
- **Some tools generate high noise levels.**
Check to be sure that the use of this tool conforms to all local noise regulations.

BEFORE OPERATION

- **Inspect tool before use.**
Before using, check that screws are securely tightened, that any protective cover or guard is securely in place, other parts are free from damage and that the tool runs as it should.
Check that moving parts are properly adjusted for positioning and tightened, that parts are free from damage and properly mounted, and that all other parts are in good condition for normal operation.
Should you find any damage to the protective cover or other part, replace it in accordance with the Operation Manual. If there are no instructions in the Manual, please contact the sales agent through which you have purchased your tool or an authorized dealer near you for repair.
Likewise, if a switch failure occurs, contact sales agent through which you have purchased your tool or an authorized dealer near you for repair.
Do not use the tool if it does not start or stop with the start/stop switch.
- **Always remove spanner, wrench, etc., once adjustment has been made with them.**
- **Use a tool appropriate for the application.**
Avoid heavy-duty application that is beyond the capacity of tool.
- **Do not use the tool for purposes other than what it is designed for.**
- **Do not abuse tool.**
Use tool in accordance with the specifications: you'll get the most out of it while ensuring safety.
- **Securely fasten workpiece in place.**
Use a vice or clamp to securely fasten the workpiece in place. It is much safer this way than holding it in your hand, allowing you to operate the tool with both hands.
- **How to store tool.**
When the tool is not used, store it in a dry area and out of reach of children.
- **How to carry tool.**
Do not touch the start switch while the tool is being carried.
- **Do not leave the tool unattended while it is running.**
Turn off the start switch and disconnect the tool from power source. Do not leave the work area until the tool comes to a complete stop.

ABOUT HANDLING

MAINTENANCE/SERVICE

- **Do not take apart or modify tool.**
Disassembly or modification carried out without the supervision of a qualified or authorized service engineer could result in an accident or injury.
- **Inspect tool and accessories, etc.**
Always check to see that tool and accessories, etc. are in good operating condition without damage or deterioration before you mount them on the tool. Should you find any damage to an accessory or part, please contact sales agent through which you have purchased your tool or an authorized dealer near you for repair.
- **Check parts for damage.**
When you have found damage to accessory or other part, carefully check the damaged part to determine the extent of influence it has upon the functions of the tool – that is, determine whether it can still perform its normal functions.
Check to see that the linkage of the moving parts is OK, that all parts are OK without damage, that they are properly mounted, and that the tool functions normally. Should you find any damage to an accessory or part that may hamper proper functioning of the tool, please contact sales agent through which you have purchased your tool or an authorized dealer near you for repair.
- **Have your tool repaired at an authorized Nitto Service Center.**
For repair or parts replacement, please contact the sales agent through which you have purchased your tool or an authorized dealer near you.
- **Use only Nitto genuine parts.**
Use of improper parts may result in serious occurrence.
To obtain a Nitto genuine part, consult this Manual or contact the sales agent from which you have purchased your tool directly.
- **Do not detach label or nameplate from tool.**
When a label/nameplate gets damaged, worn or becomes missing, contact the sales agent through which you have purchased your tool or Nitto Kohki Co. Ltd, directly for a replacement.

DISPOSAL

- When a tool is taken permanently out of service, it is advised that the tool is disassembled, degreased and parts separated by material and recycled locally in the appropriate manner.

GENERAL:PNEUMATIC TOOLS

WARNING

- **Use appropriate air pressure.**
Excessively high air pressure will increase the tool number of revolutions or strokes causing not only potential premature failure/breakage but could also lead to an unexpected accident or injury.
- **Connect tool to air supply line.**
There are various types of pipes running in a factory in addition to the pneumatic line (such as oxygen, nitrogen, gas and water). For this reason, always ensure that you are connecting to the pneumatic line.
- **Start tool properly.**
Turn the start switch OFF before connecting to the air supply line.
- **Always disconnect the tool from the air supply line before putting on/taking off any accessory and prior to carrying out any maintenance work.**
- **Avoid exposure to exhaust air.**
Pneumatic tool exhaust air contains oil and contaminated moisture. Make sure the exhaust air is not directed towards your face or anyone else within the work area.
- **Keep tool off electricity.**
This pneumatic tool is not electrically insulated. To avoid a potential electric shock do not use where there is a possibility of coming into contact with live electricity.

CAUTION

- **Handle tool carefully.**
Abusive use of tool could invite failure or accident.
Do not throw, drop or shock the tool.
- **Handle connecting hose carefully.**
Do not carry the tool by the connecting hose.
Do not pull the connecting hose to disconnect.

INSTRUCTIONS FOR THIS TOOL

About Your Tool

WARNING

- **Wear protective glasses and a dustproof mask.**
Operation generates chips and dust particles, etc. which may cause eye and/or respiratory injury: Always use PPE (Personal Protective Equipment) for eye and respiratory protection.
- **Never touch the moving parts while in operation.**

CAUTION

- **Tighten the pad securely. Insufficient tightening of screws may lead to unintended accidents.**
- **This tool is not designed for water sanding. Never use for water sanding.**
- **Use Nitto genuine parts polishing pad.**
- **Whenever you replace or adjust the polishing pad or any component, be sure to detach the tool from the air.**

1. USAGE

This tool is for sanding workpieces using Abrasive Paper.

2. CHECK THE CONTENTS OF THE PACKAGE

Check the contents and make sure that the tool does not have any damage which may have occurred during transportation. The contents should correspond to the list as follows. In case of damage/missing parts, please contact the sales agent from whom you purchased the tool.

Package Contents	Qty	Check
COMPACT MULTI SANDER CMX-20	1	
Hex Socket Screw Key 4	1	
Ultra-Thin Wrench SNT1012	1	
Instruction Manual	1	
Attention for Start-Up	1	
Caution for Use	1	
Declaration of Conformity	1	
2" Pad	1	
Rectangular Pad	1	
Finger Pad	1	
2" Velcro Abrasive Disc #80	2	
2" Velcro Abrasive Disc #120	2	
2" Velcro Abrasive Disc #180	2	
50x26mm Velcro Abrasive Sheet #80	2	
50x26mm Velcro Abrasive Sheet #120	2	
50x26mm Velcro Abrasive Sheet #180	2	
50x26 Non-woven Abrasive Pad Velcro Backed #320	5	
16mm Self Adhesive Abrasive Disc #80	5	
16mm Self Adhesive Abrasive Disc #120	5	
16mm Self Adhesive Abrasive Disc #180	5	

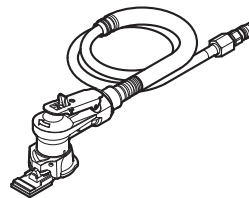

Tool Body

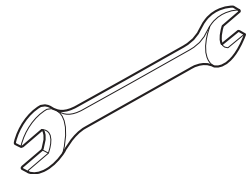

Ultra-Thin Wrench SNT1012

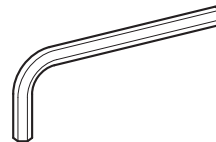

Hex Socket Screw Key 4

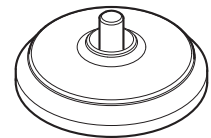

2" Pad

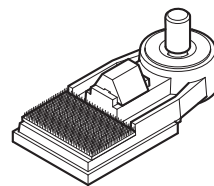

Rectangular Pad

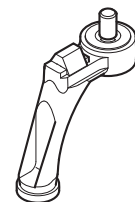

Finger Pad



2" Velcro Abrasive Disc

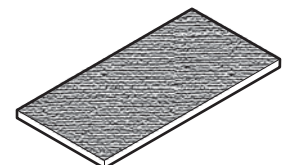

50x26mm Velcro Abrasive Sheet

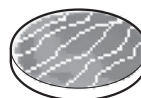

16mm Self Adhesive Abrasive Disc

3. NAME OF PARTS

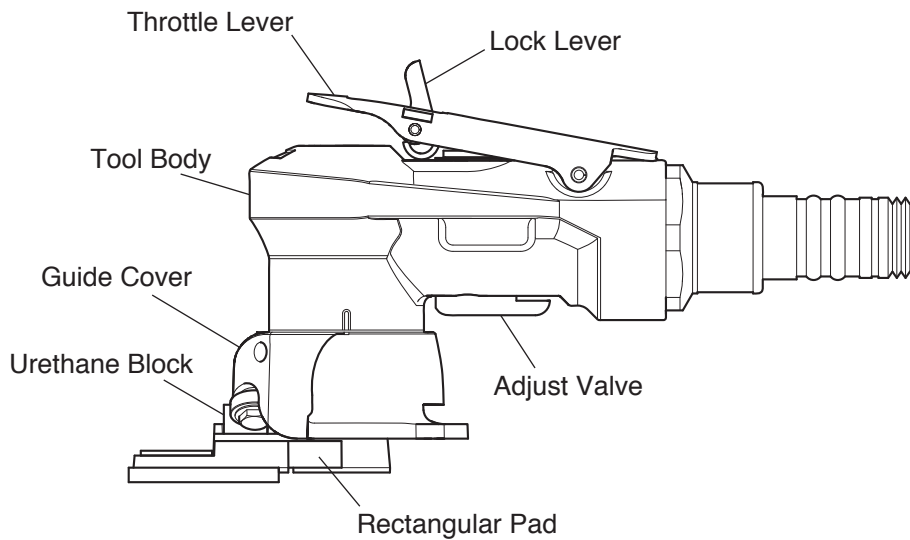

Fig. 1

4. AIR SUPPLY

⚠ CAUTION

- Draw off drainage before starting operation. If the drainage enters into the tool, it can freeze around the exhaust port of the tool and result in output power reduction.

4-1. Air Pressure

Adjust air pressure to 0.6MPa (or 6 kgf/cm²) with the air regulator. Lower pressure may result in insufficient performance. Higher pressure may result in premature wornout of parts. It is important to maintain the proper pressure with pressure regulator on air line.

4-2. Air Line (Fig.2)

Use a 9.5 mm (3/8") I.D. air hose between the compressor and the tool. Compressed air comes to be cooled down and its drain be separated, as soon as the air leaves the compressor. The drain, however, is condensed in the piping, and can enter into the tool mechanism, and may cause malfunction. So, install an air filter and an oiler between the compressor and the tool.

4-3. Oiler

Install an oiler between the compressor and the tool. Use machine oil ISO VG-10 for lubrication and rust prevention. Negligence of the oil supply may cause damages on the tool. Lubricating the tool with high viscosity oil reduces the tool performance.

4-4. Lubrication (Fig.2)

Before starting the tool, disconnect air hose from the tool and supply a few drops of machine oil ISO VG-10 to the air inlet port of the tool. Then reconnect and make idle running for a few seconds so that the oil should reach every part in the tool.

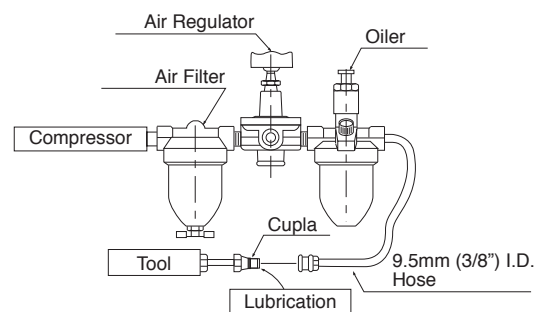

Fig. 2

5. HOW TO OPERATE THE TOOL

5-1. Method to Replace Polishing Pad (Figures 3&4)

⚠ WARNING

- Turn the throttle lever to OFF and detach the connecting hose before performing replacement of the polishing pad.
- Polishing pads must be attached securely.

Removal

○ 2" Pad

Lock the spindle with the provided Ultra-Thin Wrench SNT1012 and turn the polishing pad counterclockwise (CCW).

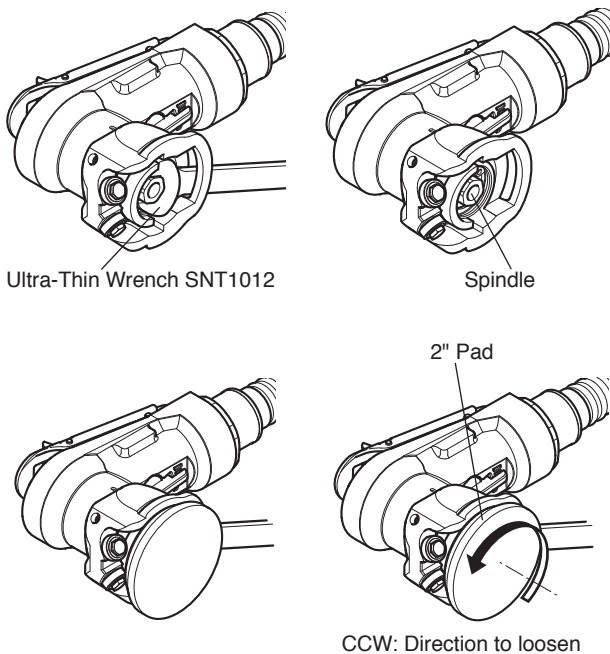

Fig.3

○ Rectangular Pad & Finger Pad

With the spindle locked with the provided Ultra-Thin Wrench SNT1012, turn the fixing bolt counterclockwise from the bottom of the polishing pad using a Hex. Socket Screw Key 4.

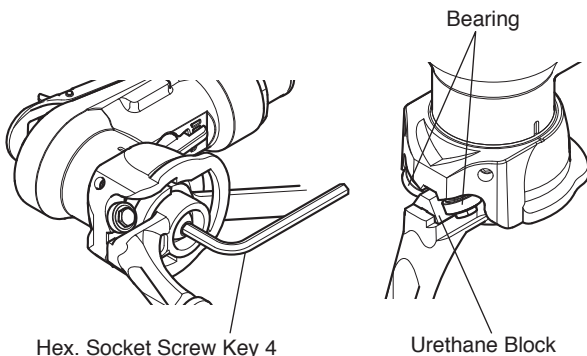

Fig.4

Installation

○ 2" Pad

Lock the spindle with the provided Ultra-Thin Wrench SNT1012 and turn the polishing pad clockwise (CW).

○ Rectangular Pad & Finger Pad

With the spindle locked with the provided Ultra-Thin Wrench SNT1012, turn the fixing bolt clockwise from the bottom of the polishing pad using the provided Hex. Socket Screw Key 4.

5-2. Replacement of Abrasive Paper

⚠ WARNING

- Perform the work with the tool detached from the connecting hose.

Attach Abrasive paper that matches the size of the pad.

Rectangular Pad - 50x26mm Velcro Abrasive Sheet

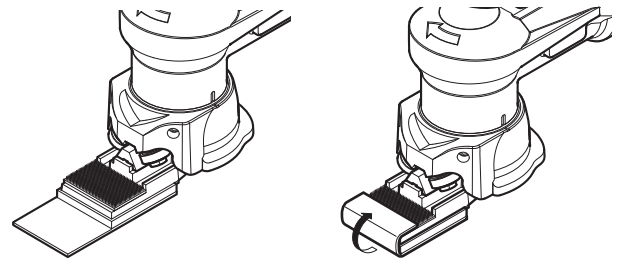

Abrasive paper installation (Bottom face) Abrasive paper installation (Top face)

Finger Pad - 16mm Self Adhesive Abrasive Disc

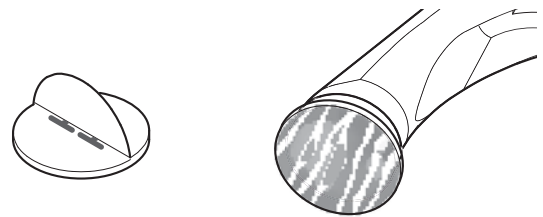

Remove the release paper of Abrasive paper and stick onto the leather face at the tip of the finger pad.

2" Pad - 2" Velcro Abrasive Disc

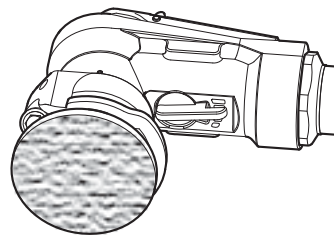

Attach in such a manner to achieve even adhesion to the pad.

5-3. Start and Stop (Fig.5)

- (1) Check that the Throttle Lever is turned off and connect the tool to the hose leading to air supply line.
- (2) Hold the tool, ① release the Lock Lever, and ② grasp the Throttle Lever to start.
- (3) When the Throttle Lever is released, it will automatically turn off.

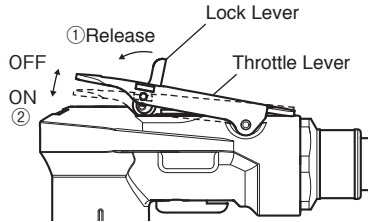

Fig.5

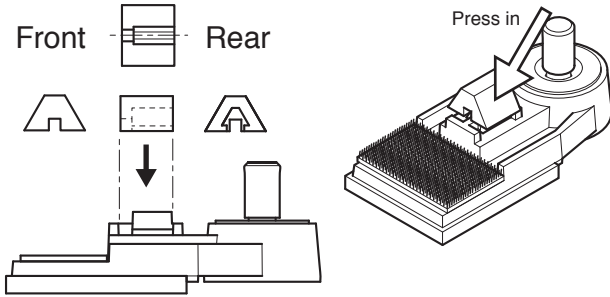
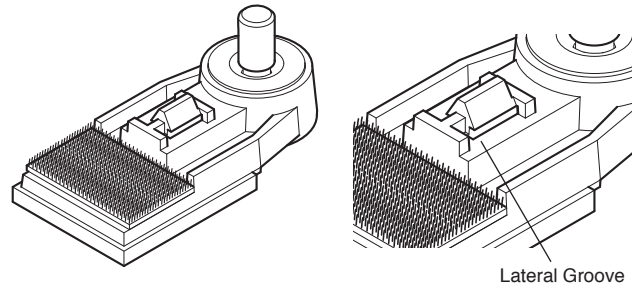

Fig.7

5-4. Method to Replace Urethane Block

(Figures 6 & 7)

This urethane block is a consumable part. It needs to be replaced after certain usage due to wear.

CAUTION

- Confirm that the urethane block is installed and check for damages before using the rectangular pad and finger pad.

Removal Method

Lift and remove the urethane block by squeezing a flat head screwdriver and so forth in the gap between the base of the block and the polishing pad. (Fig.6)

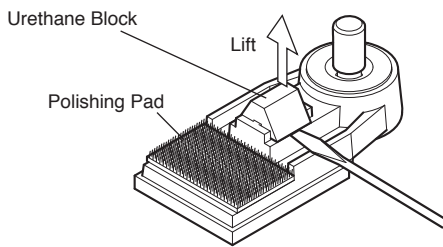

Fig.6

Installation Method

Push in the urethane block in the correct fore-aft orientation in relation to the polishing pad and press the base of the urethane block onto the lateral groove in the polishing pad. (Fig.7)

5-5. Adjustment of Revolution (Fig.8)

WARNING

- Never touch any moving parts of the tool when running.

When the adjust valve is turned, the amount of airflow is changed to adjust the rotation speed. When the adjust valve is turned to the furthest counterclockwise position, the tool reaches the maximum rotation speed. (Fig.8) Adjust the rotation speed according to the chamfering work.

*Please note that dropping the revolution by turning the adjust valve may worsen the starting ability

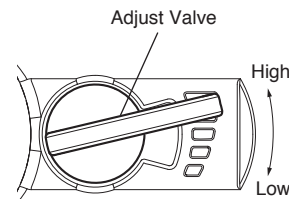

Fig.8

5-6. Sanding Operations

WARNING

- Be sure to wear appropriate safety glasses and dustproof mask during operation.
- Do not apply unnecessarily strong force. It may cause breakage of the polishing pad.

Start the tool, lightly press the polishing pad against the workpiece, and carry out the operation.

6. STORAGE

CAUTION

- **When tool is not used, store it out of reach of children.**

Avoid storing the tool in a location subject to high humidity. If the tool is left as it is used, residual moisture on the inside can cause rusting. Before storing, and after operation, oil the tool at the air inlet with machine oil ISO VG-10 and run it for a short time.

7. ORDERING SERVICE PARTS

- **For further operational and handling information or for replacement of parts and components, contact the company from whom you purchased the tool or an authorized dealer.**
- **In ordering parts and components give each part number, part name and quantity required.**
- **Use only NITTO genuine parts.**

8. OPTIONAL PARTS

Part No.	Description	Qty
TB09977	50x26mm Velcro Abrasive Sheet #80	100pcs.
TB09978	50x26mm Velcro Abrasive Sheet #120	100pcs.
TB09979	50x26mm Velcro Abrasive Sheet #180	100pcs.
TB09980	2" Velcro Abrasive Disc #80	100pcs.
TB09981	2" Velcro Abrasive Disc #120	100pcs.
TB09982	2" Velcro Abrasive Disc #180	100pcs.
TB09983	16mm Self Adhesive Abrasive Disc #80	100pcs.
TB09984	16mm Self Adhesive Abrasive Disc #120	100pcs.
TB09985	16mm Self Adhesive Abrasive Disc #180	100pcs.
TB09986	50x26mm Non-woven Abrasive Pad Velcro Backed #320	50pcs.

9. EXPLODED DIAGRAM: CMX-20

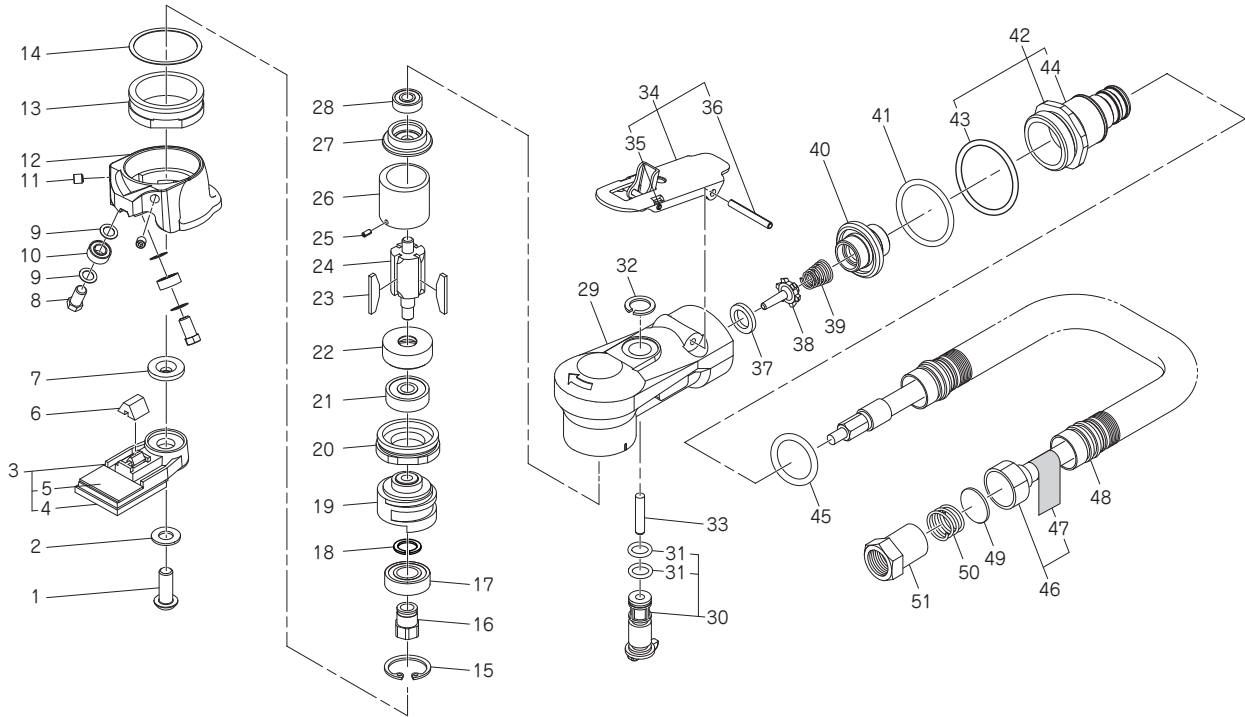

The Part number with () are included in the Ass'y parts written above them.

No.	Part No.	Description	Qty
1	TQ14420	Hex. Socket Head Cap Screw M6	1
2	TP12066	Washer M6	1
3	TB09789	Rectangular Pad V Sub Ass'y	1set
4	(TB09914)	Rectangular Pad 26x31 V Sub Ass'y	1set
5	(TQ14417)	Velcro 26x31	1
6	TQ14419	Urethane Block	1
7	TQ14421	Spindle Seat	1
8	TQ14412	Hex. Head Bolt M5	1
9	TQ14413	Shim 5.1x8x0.3	4
10	TQ14414	Ball Bearing DDL-1050ZZR	2
11	TP15643	Hex. Socket Set Screw with Flat Point M4x4	2
12	TB09784	Guide Cover Ass'y	1set
13	TQ14580	Lock Nut	1
14	TQ14579	Shim 28x32x0.3	1
15	TP10127	Internal Retaining Ring C-20	1
16	TQ14408	Spindle	1
17	TQ14406	Ball Bearing 699-2RS	1
18	TQ14407	External Retaining Ring ISTW-9	1
19	TQ14405	Counter Weight	1
20	TQ14404	Lock Screw	1
21	TQ14578	Ball Bearing 626ZZ LP03	1
22	TQ13345	End Plate B	1
23	TB09122	Blade Ass'y (4pcs.)	1set
24	TQ14403	Rotor	1
25	TP04225	Spring Pin 2x4	1
26	TQ13346	Cylinder	1
27	TQ13344	End Plate A	1
28	TQ07225	Ball Bearing 695ZZ	1
29	TQ13381	Housing	1
30	TB09123	Adjust Valve Ass'y	1set
31	(TP12003)	O-ring KS-5	2
32	(TQ13374)	External Retaining Ring ISTW-10	1
33	TQ13454	Parallel Pin B4x20	1
34	TB09088	Lever Ass'y	1set
35	(TQ13429)	Spring Pin 2.5x25	1
36	(TQ13428)	Spring Pin 3x25	1

No.	Part No.	Description	Qty
37	TQ04671	Seal Sheet 9x13.9x2	1
38	TQ04664	Valve	1
39	TQ04665	Conical Spring 0.8x6.4x11.6x21.8	1
40	TQ14409	Connection	1
41	LQ01493	O-ring S-22.4	1
42	TB10035	Hose Holder Ass'y	1set
43	(TP08812)	O-ring S-25	1
44	(TQ14773)	Label Model	1
45	CP28152	O-ring JASO-1012	1
46	TB08130	Air Hose J Ass'y	1set
47	(TQ11519)	Label Lubrication	1
48	TQ04367	Exhaust Hose	1
49	TQ13625	Filter	1
50	TQ13621	Filter Spring	1
51	TQ04709	Bushing R1/4xRc1/4	1

Accessories

No.	Part No.	Description	Qty
	TB09786	2" Pad V-NH CR Ass'y	1set
	(TB09913)	2" Pad V-NH Sub Ass'y	1set
	TB09788	Finger Pad L Ass'y	1set
	(TB09915)	Pad 15 L Sub Ass'y	1set
	TP01939	Hex. Socket Screw Key 4	1
	TQ14431	Ultra-Thin Wrench SNT1012	1
	TB09953	Tool Box Ass'y	1set
	TQ14772	Instruction Manual	1
	TQ14582	50x26mm Velcro Abrasive Sheet #80	2
	TQ14583	50x26mm Velcro Abrasive Sheet #120	2
	TQ14584	50x26mm Velcro Abrasive Sheet #180	2
	TQ14585	2" Velcro Abrasive Disc #80	2
	TQ14586	2" Velcro Abrasive Disc #120	2
	TQ14587	2" Velcro Abrasive Disc #180	2
	TQ14588	16mm Self Adhesive Abrasive Disc #80	5
	TQ14589	16mm Self Adhesive Abrasive Disc #120	5
	TQ14590	16mm Self Adhesive Abrasive Disc #180	5
	TQ14591	50x26mm Non-woven Abrasive Pad Velcro Backed #320	5

■ Overseas Affiliates / Offices

NITTO KOHKI U.S.A., INC.

46 CHANCELLOR DRIVE, ROSELLE,
IL 60172 U.S.A.

TEL: +1-630-924-9393 FAX: +1-630-924-0303

NITTO KOHKI EUROPE CO., LTD.

UNIT A5, LANGHAM PARK INDUSTRIAL ESTATE,
MAPLE ROAD, CASTLE DONINGTON,
DERBYSHIRE DE74 2UT, U.K.

TEL: +44-1332-653800 FAX: +44-1332-987273

NITTO KOHKI DEUTSCHLAND GMBH

GOTTLIEB-DAIMLER-STR.10 D-71144
STEINENBRONN, GERMANY

TEL: +49-7157-989555-0 FAX: +49-7157-989555-40

NITTO KOHKI CO., LTD., SINGAPORE BRANCH

10 UBI CRESCENT #01-62,
UBI TECHPARK LOBBY D, SINGAPORE 408564,

TEL: +65-6227-5360 FAX: +65-6227-0192

NITTO KOHKI AUSTRALIA PTY. LTD.

77 BRANDL ST., BRISBANE TECHNOLOGY PARK,
EIGHT MILE PLAINS QLD 4113 AUSTRALIA

TEL: +61-7-3340-4600 FAX: +61-7-3340-4640

NITTO KOHKI CO., LTD.,

BANGKOK REPRESENTATIVE OFFICE

M&A BUSINESS CENTER 38Q. HOUSE CONVENT BLDG.,
7TH FLOOR, UNIT 7A, CONVENT RD., SILOM, BANGRAK,
BANGKOK 10500 THAILAND

TEL: +66-2-632-0307 FAX: +66-2-632-0308

NITTO KOHKI (SHANGHAI) CO., LTD.

ROOM1506, SUITE C, ORIENT INTERNATIONAL PLAZA,
NO85 LOUSHANGUAN ROAD, SHANGHAI, 200336, CHINA

TEL: +86-21-6415-3935 FAX: +86-21-6472-6957

NITTO KOHKI CO., LTD.,

SHENZHEN REPRESENTATIVE OFFICE

2005C SHENZHEN ICC TOWER, FUHUASANLU 168,
FUTIAN DISTRICT, SHENZHEN, GUANGDONG, 518048 CHINA

TEL: +86-755-8375-2185 FAX: +86-755-8375-2187

EC DECLARATION OF CONFORMITY

We hereby declare that the following our product conforms with the essential health and safety requirements of EU Directives.

Brand Name: NITTO KOHKI
Product: PNEUMATIC SANDER
Model: CMX-20
Serial No: In the case of 6 digits serial number.

X X X X X X
→ Consecutive numbers (00001~99999)
→ Last digit (0-9) of year (A.D.)

In the case of 7 digits serial number.

X X X X X X X
→ Consecutive numbers (00001~99999)
→ Last two digits (00-99) of year (A.D.)

Manufacturer: NITTO KOHKI Co., Ltd.
9-4, NAKAIKEGAMI 2-CHOME, OHTA-KU, TOKYO, 146-8555, JAPAN

Authorised person to prepare the technical construction file(TCF) in the community:

Masatoshi Ogue
President
NITTO KOHKI EUROPE Co., Ltd.
UNIT A5, LANGHAM PARK INDUSTRIAL ESTATE, MAPLE ROAD,
CASTLE DONINGTON, DERBYSHIRE DE74 2UT, U.K.
Tel:+44-1332-653800 Fax:+44-1332-987273

Directive: 2006/42/EC Machinery Directive

The above product has been evaluated for conformity with above directives using the following European standards. The technical construction file (TCF) for this product is retained at the above manufacturer's location.

Machinery Directive: EN ISO12100:2010, EN ISO11148-8:2011, others
Sound Pressure/Power Level: EN ISO15744:2008, EN ISO4871:2009
Vibration Level: EN28927-3:2009

Signature: _____

Date/Place: _____ /TOKYO, JAPAN

Name: Katsunobu Kishi

Title: General Manager, MACHINE TOOLS Business Div.

NITTO KOHKI Co., Ltd.
9-4, NAKAIKEGAMI 2-CHOME, OHTA-KU, TOKYO, 146-8555, JAPAN

Being the responsible person appointed and employed the manufacturer.